

Improving the Sensoring of PEM Fuel Cell by Numerical Techniques

Sandro Skoda¹, Eric Robalinho^{2*}, Edgar F. Cunha¹, Marcelo Linardi¹

1. IPEN/CNEN-SP, Av. Prof. Lineu Prestes, 2242, Cidade Universitária, São Paulo, SP, Brazil
2. Universidade Nove de Julho - UNINOVE, Rua Vergueiro, 235, São Paulo, SP, Brazil

*e-mail: eric@ipen.br

Introduction: This work presents the application of numerical techniques in a model of PEM fuel cell with the objective of improving the sensing of water and oxygen mole fractions at the cathode. The fuel cell has 5 cm² of geometric area and the COMSOL Multiphysics® CFD and Chemical Reaction Engineering modules allowed the implementation of the problem and its complex multiphysics. The domain geometry is showed in Figure 1(a), and the multilayer physics of the cell is presented in Figure 1(b).

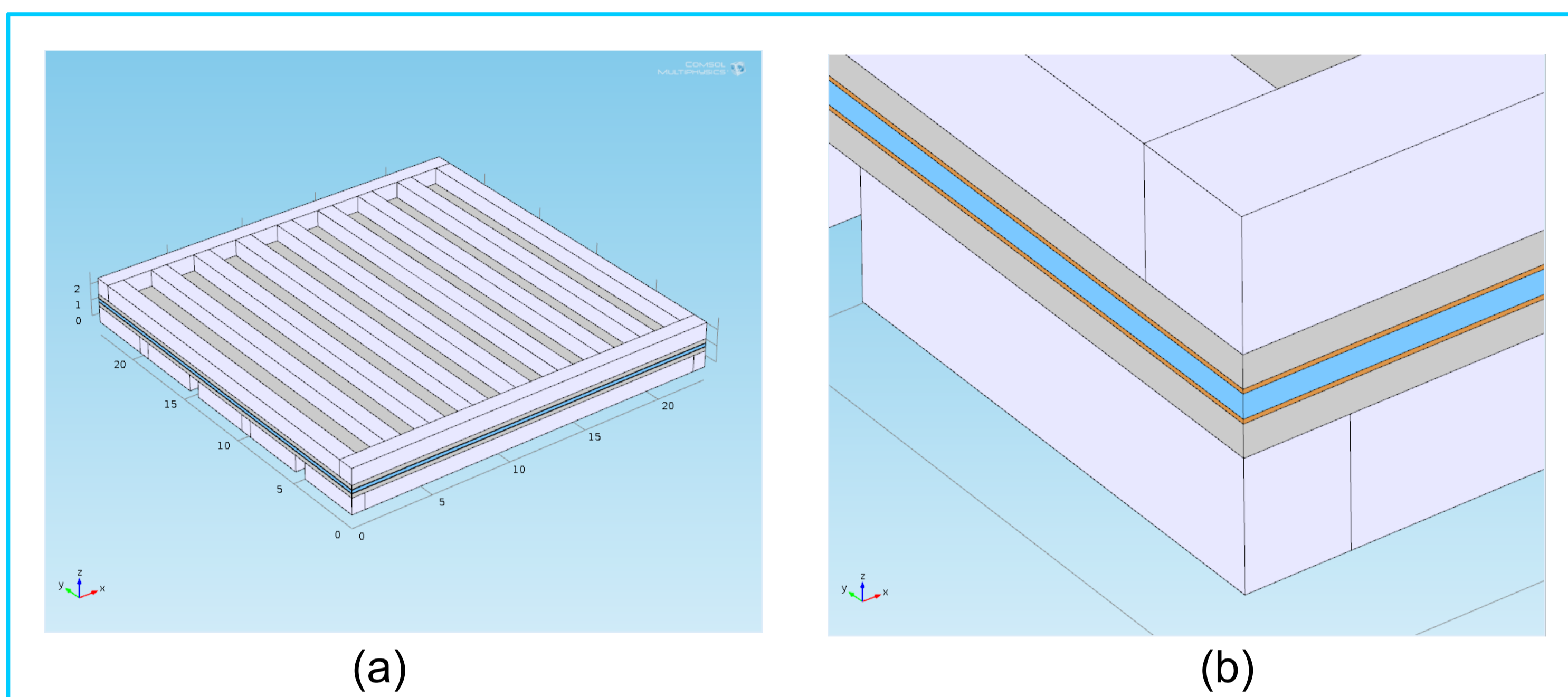

Figure 1. Fuel Cell geometry with (a) parallel channels and (b) multilayer view.

Computational Methods: The model makes use of the Free and Porous Media Flow, Transport of Concentrated Species and Secondary Current Distribution physics interfaces. The need to recognize a geometric figure of merit that meaning the region of sensing, led us to define the lines localized in the center of the cell.

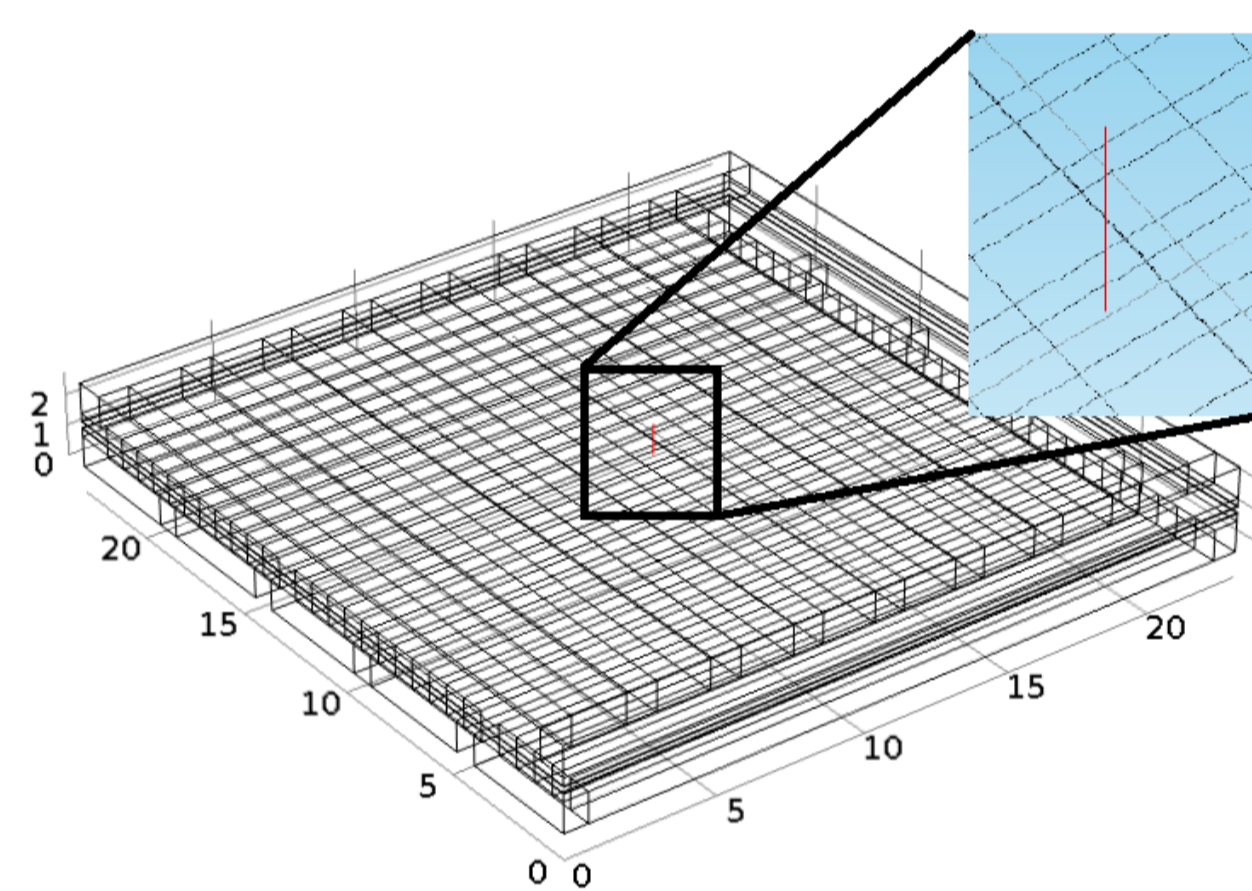

Figure 2. Vertical line sensing.

Figure 2 shows one vertical line and Figures 3 and 4 show horizontal lines (11 lines and 2 lines, respectively), used in order to take the readings from the model. These lines are localized in the middle plane of the central channel of the cell (inset of Figure 3). These detection lines represent the numerical readings, that are very interesting to the fuel cell researcher, because they capture important information about oxygen and water at cathode domain.

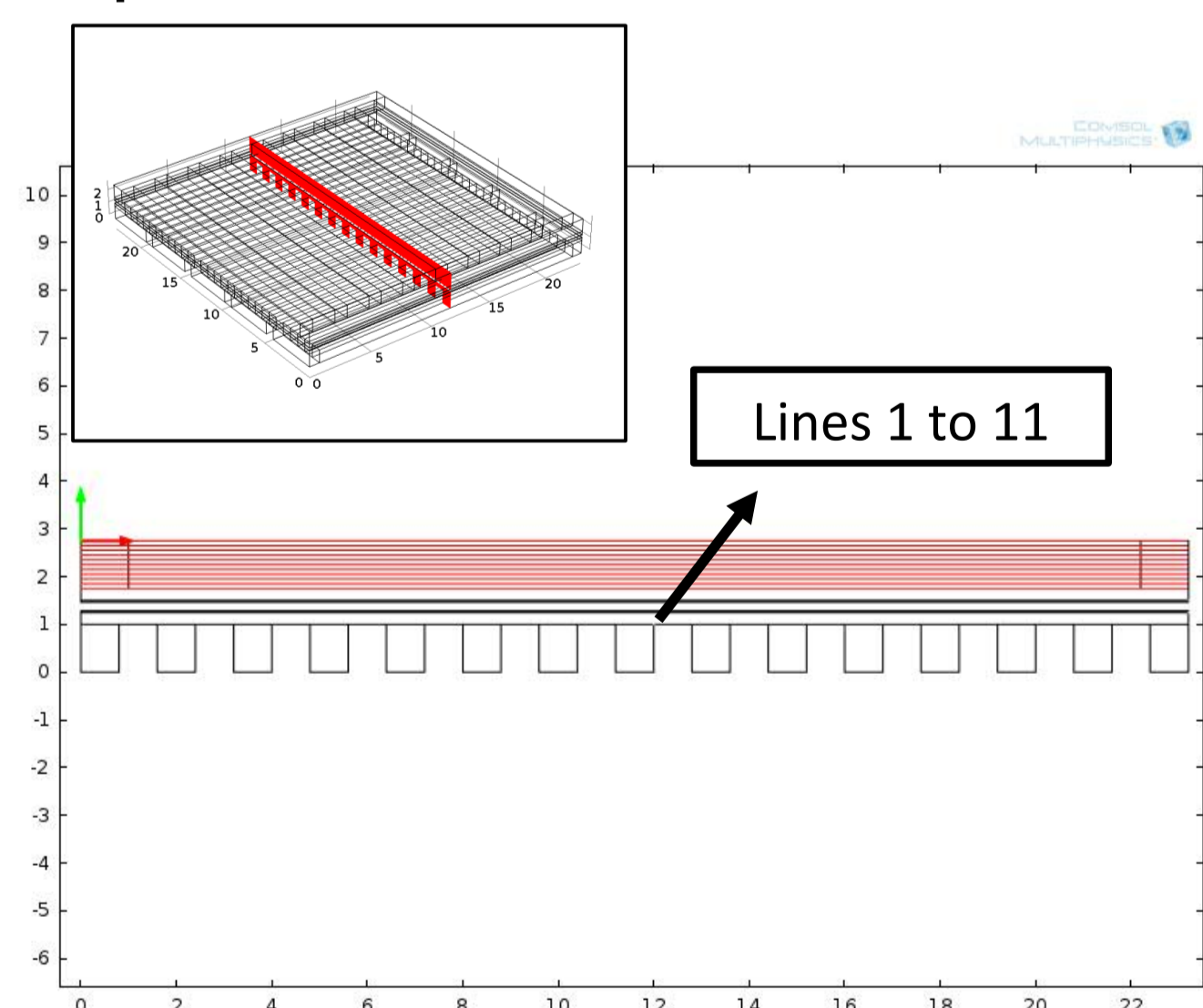

Figure 3. Horizontal lines sensing. (inset: middle plane)

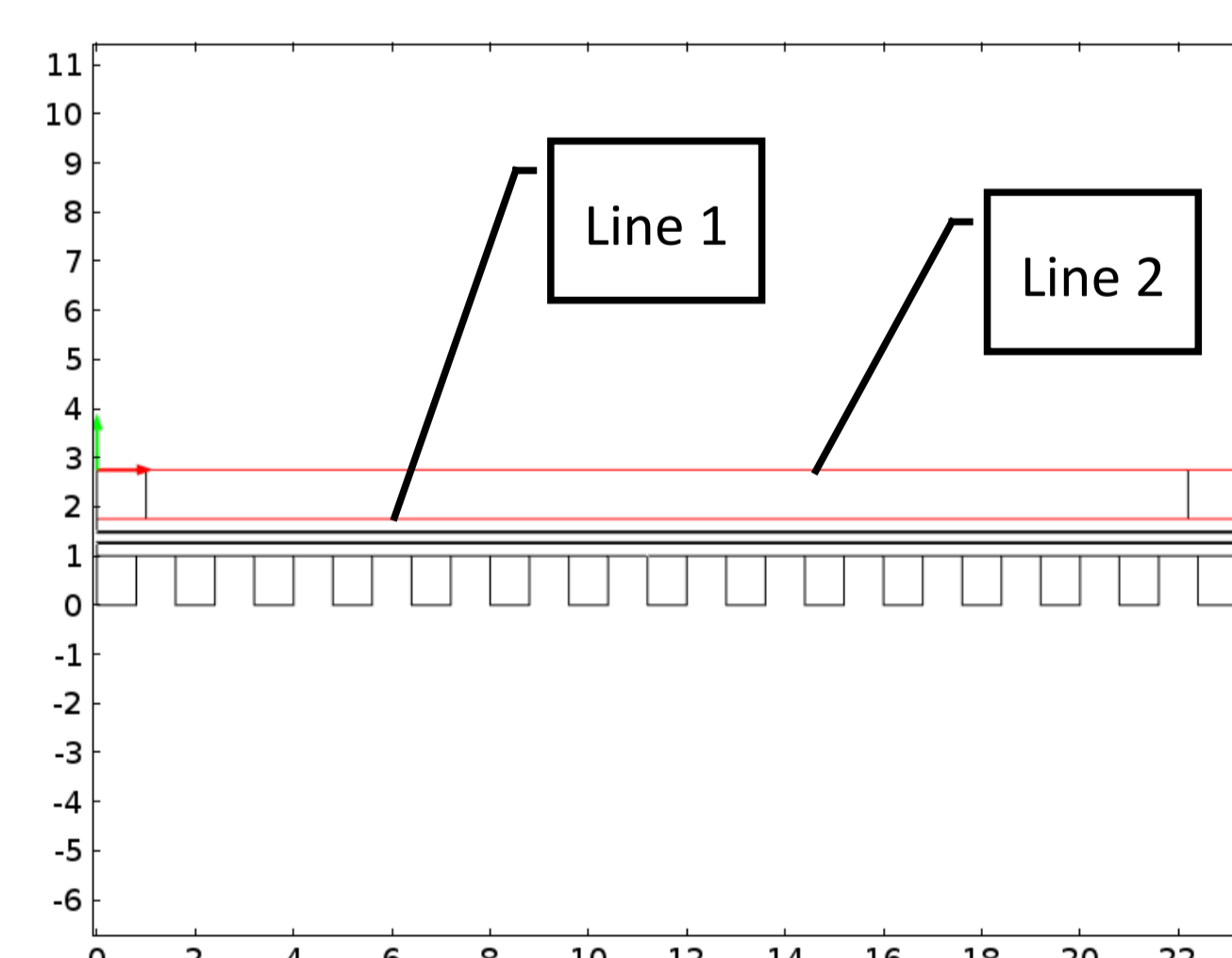

Figure 4. Horizontal lines sensing.

Experimental setup: The unitary fuel cell operated in the laboratory is showed in Figure 5. It has 5 cm² of geometric area and a cathodic side made of a golden channel flow plate and a polycarbonate endplate.



Figure 5. PEM Fuel Cell setup.

Results: Figures 6(a) and 6(b) present the variation of the oxygen molar fraction along the horizontal lines (11 lines (a) and 2 lines (b)), in the range of 0.1 – 0.95 V, at 308 K. Figure 7 presents the variation of oxygen molar fraction along the vertical line, in the range of 0.1 – 0.9 V, at 298 K, 308 K, 318 K and 328 K. The polarization curves are showed in Figure 8, presenting a good correlation of experimental and numerical responses at 298 K, 308 K, 318 K and 328 K.

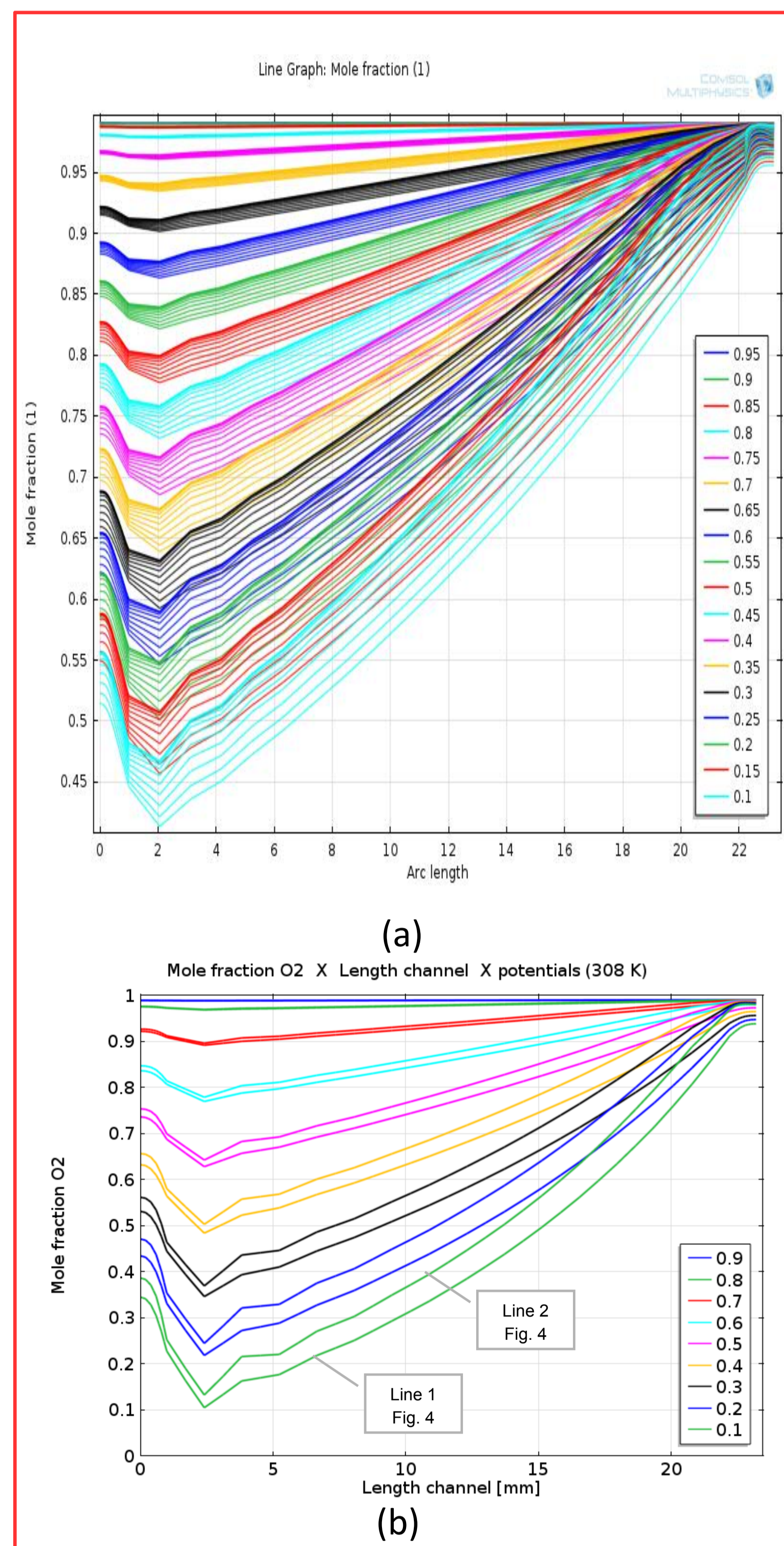

Figure 6. Oxygen molar fraction values along the horizontal lines, T=308 K.

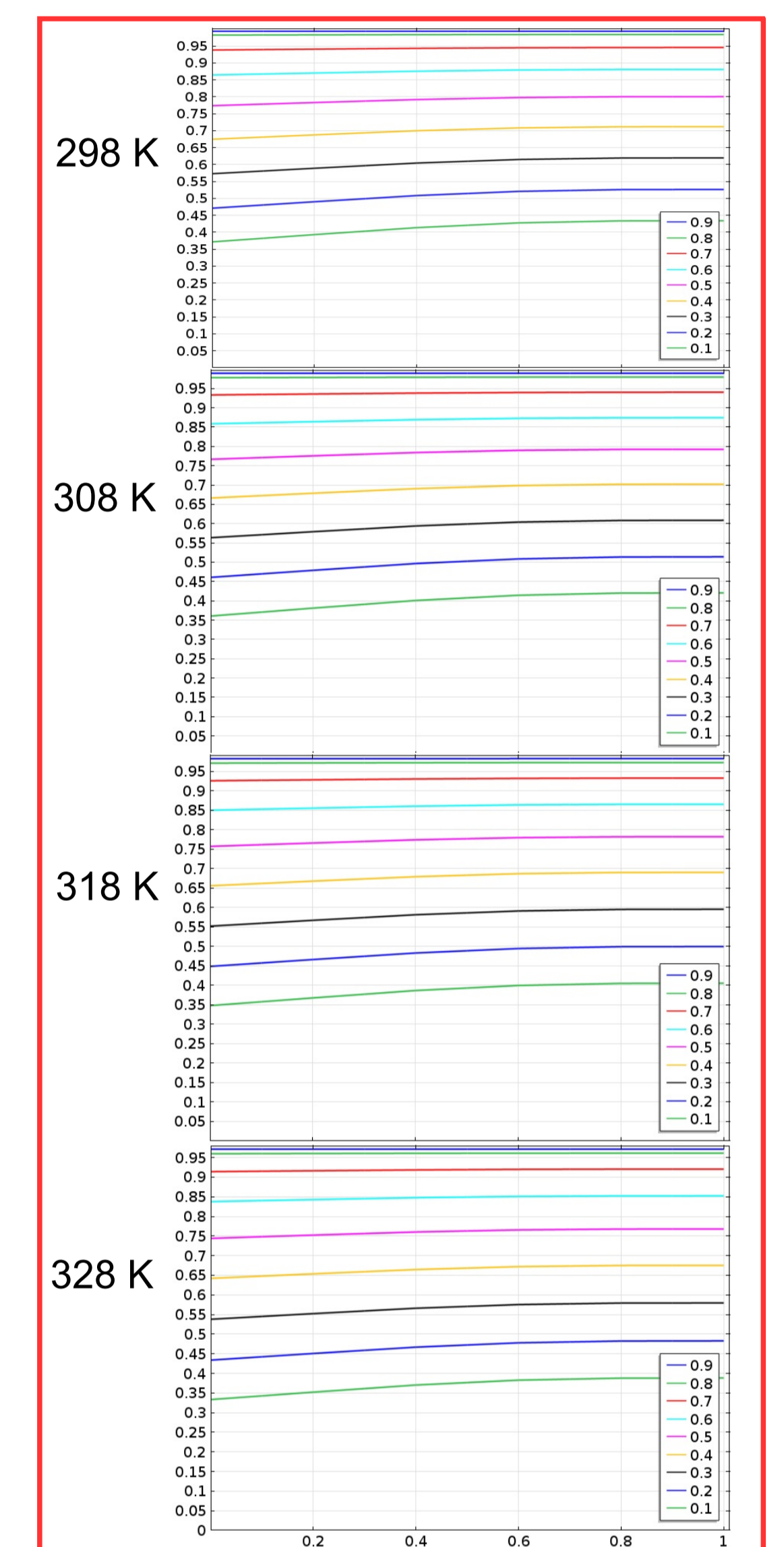

Figure 7. Oxygen molar fraction values along the vertical line.

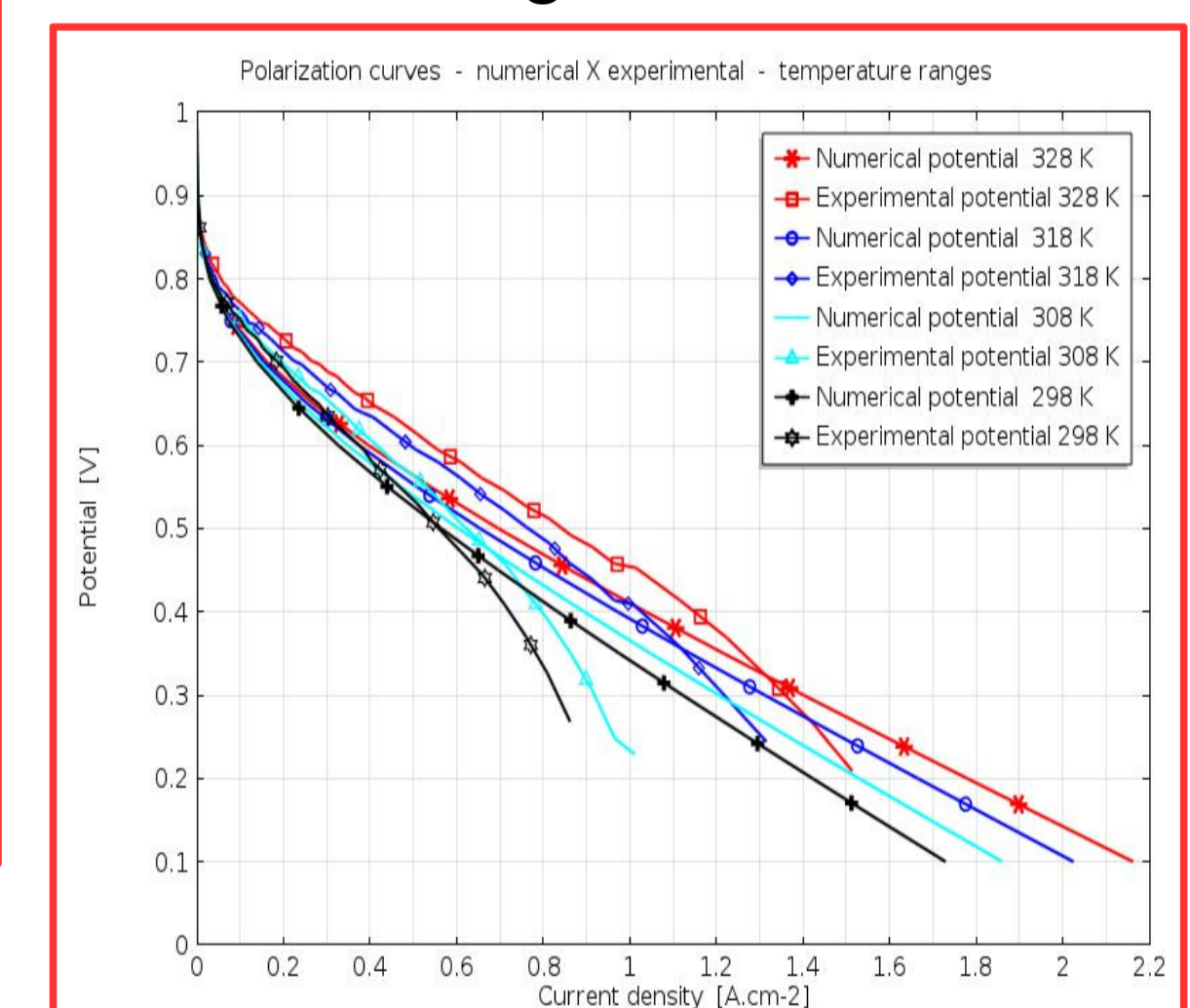

Figure 8. Polarization curves.

Conclusions: The numerical results allow to predict the behavior of the PEM fuel cell when it works in low temperatures, that is, condition in which the efficiency control is more difficult. Usually, flooding problems are observed in this context. The study of phenomena and the control of operating conditions are very difficult tasks for researchers and the use of numerical sensing is of great help, when allied to the experimental results.

Acknowledgments



References

- M. Linardi, Introdução à Ciência e Tecnologia de Células a Combustível, Art Lieber Editora, São Paulo, SP, 2010.
- F. Barbir, PEM Fuel Cells – Theory and Practice, Elsevier Academic Press, 2005.
- S. Skoda, E.Robalinho, A.L.R.Paulino, E.F.Cunha, M.Linardi, Modeling of Liquid Water Distribution at Cathode Gas Flow Channels in Proton Exchange Membrane Fuel Cell – PEMFC, Proceedings of the COMSOL Conference 2013, Rotterdam, ND, 2013.
- E. Robalinho, Desenvolvimento de um modelo numérico computacional aplicado a uma célula a combustível unitária de 144 cm² do tipo PEM. PhD Thesis, São Paulo, SP, Brazil, 2009.