

# Multiphysics Analysis of Electromagnetic Flow Valve

Jeffrey S. Crompton\*, Kyle C. Koppenhoefer, and Sergei Yushanov

AltaSim Technologies, LLC

\*Corresponding author: 130 E. Wilson Bridge Road, Suite 140, Columbus, OH 43085,  
jeff@altasimtechnologies.com

## Abstract

This paper demonstrates the use of COMSOL Multiphysics to solve the problem of flow using an electromagnetic solenoid valve. Analysis of the valve is conducted as a single, integrated, fully coupled multiphysics analysis using COMSOL Multiphysics in which the electromagnetic response, structural response and fluid flow are solved simultaneously. Valve operation is analyzed as a fully coupled electromagnetic-fluid-structure problem in which the motion of a plunger operates against a spring to control flow of pressurized fluid through an orifice

**Keywords:** Electromagnetics, CFD, moving mesh, coupled analysis.

## 1. Introduction

Solenoid valves control fluid flow in a variety of applications and are actuated by the passage of an electric current that develops a magnetic field that controls the displacement of a plunger. With increasing electric current the plunger moves progressively upward, thus controlling the flow of fluid through an orifice, Figure 1.

The nature of the operation of a solenoid valve is inherently multiphysics, relying on electromagnetically induced forces to impart structural changes that control fluid flow thus creating a fully coupled electromagnetic-fluid-structure interaction.

In the current work the operation of a solenoid valve is analyzed as a fully coupled electromagnetic-fluid-structure problem in which the motion of a plunger operates against a spring to allow flow of pressurized fluid through an orifice. Initially the spring holds the plunger closed against the force due to the pressurized fluid. The plunger material has a non-linear magnetic B-H response such that current passing through an electromagnetic coil surrounding the

plunger generates an electromagnetic force on the plunger. A spring resists motion of the plunger to control the plunger; an increase in the current flowing through the coil is required to increase plunger displacement, increase the size of the opening and allow more fluid flow.

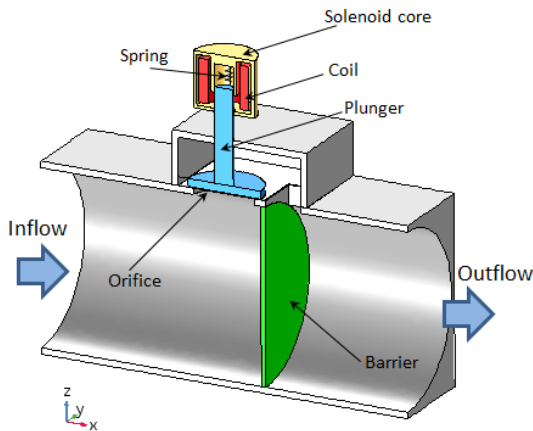
## 2. Numerical model and governing equations

Analysis of the solenoid valve behavior is conducted as a single, integrated, fully coupled multiphysics analysis using COMSOL Multiphysics in which the electromagnetic response, structural response and fluid flow are solved simultaneously. An electromagnetic analysis calculates the electromagnetic force induced in the plunger represented as material having a non-linear magnetic B-H behavior, the fluid is modeled as incompressible viscous fluid flow.

Analysis of valve operation involves the coupling of the following interfaces in COMSOL Multiphysics: Magnetic Fields (mf), Laminar Flow (spf), Global ODEs and DAEs (ge), and Moving Mesh (ale).

### 2.1 Valve geometry

The geometry of the electromagnetic valve is shown in Figure 1. The valve has an inlet diameter of 56 mm and an orifice diameter of 20 mm, the diameter of the plunger is 24 mm. The plunger shaft has diameter of 6 mm and the initial gap between the plunger and orifice is 0.2 mm.

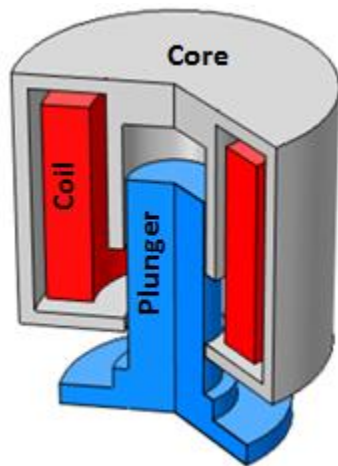


**Figure 1.** Geometry of the electromagnetic valve.

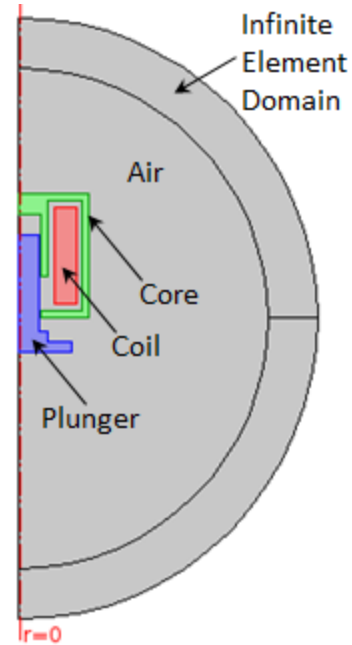
## 2.2 Electromagnetic Model

A cross-sectional view of the electromagnetic model is shown in Figure 2. The model consists of three parts: coil, core, and plunger. The inner and outer diameters of the coil winding are 10.4 mm and 16.4 mm, respectively. The coil length is 13.8 mm, the width of the air gap between the plunger shaft and the core is 0.2 mm in the radial direction and the core wall thickness is 1 mm.

The model includes air surrounding the three parts, Figure 3, and this domain is truncated by the Infinite Element Domain feature available in COMSOL Multiphysics. This feature performs a mathematical stretching of the domain layer so that it becomes equivalent to an infinitely large air domain.

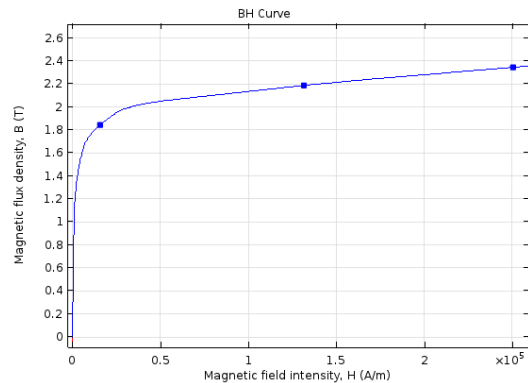


**Figure 2.** Schematic 3D diagram of electromagnetic model.



**Figure 3.** Geometry of the 2D axisymmetric electromagnetic FE analysis model.

The plunger and core are modelled as magnetic materials with magnetic properties of cast steel. The B-H curve accounts for the magnetic saturation at high field intensities, as shown in Figure 4.



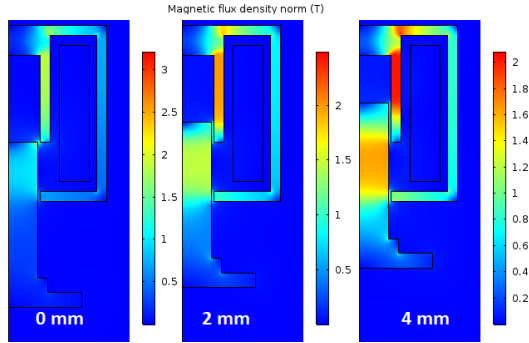
**Figure 4.** Nonlinear B-H curve of the plunger and core

The Multi-Turn Coil feature provides the capability to model the coil with the number of turns in the coil winding assumed to be 500.

The *Magnetic Fields (mf)* COMSOL interface is used to solve the second Maxwell's equation (Ampere law):

$$\nabla \times \mathbf{H} = \mathbf{J}$$

The distribution of the magnetic field for various positions of the plunger is shown in Figure 5.

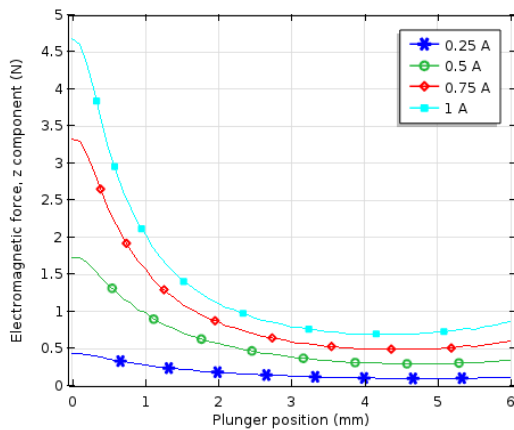


**Figure 5.** Magnetic flux density at various plunger positions.

The force on the plunger is calculated using an integration of the Maxwell stress tensor over the plunger boundary:

$$\mathbf{F}_{EM} = \int_{\partial\Omega} \mathbf{n} \cdot \left[ \mathbf{H}\mathbf{B}^T - \frac{1}{2}(\mathbf{H} \cdot \mathbf{B})\hat{\mathbf{i}} \right] dS$$

The dependencies of the electromagnetic force on coil current and plunger positions are shown in Figure 6. This force is used in the subsequent analysis of the plunger dynamics during fluid flow through the orifice.



**Figure 6.** Magnetic flux density at various plunger positions.

### 2.3 Plunger Dynamics

The plunger is modelled as a rigid body and attached to a spring with a spring constant

$k$  [ $N/m$ ] and damping coefficient  $D$  [ $N \cdot s/m$ ]. The equation of motion of the plunger is given by following equation:

$$M_p \frac{d^2 U_0}{dt^2} + D \frac{dU_0}{dt} + kU_0 - (F_{CFD} + F_{EM} - F_{init}) = 0$$

where

$U_0$  plunger position

$M_p$  : mass of the plunger

$F_{CFD}$  : force on the plunger due to flow

$F_{EM}$  : electromagnetic force on the plunger

$F_{init}$  : spring initial compression force

The equation of plunger motion can be rewritten into two separate differential equations for the plunger position,  $U_0$ , and plunger velocity,  $V_0$ , as:

$$M \frac{dV_0}{dt} + DV_0 + kU_0 - (F_{CFD} + F_{EM} - F_{init}) = 0$$

$$\frac{dU_0}{dt} - V_0 = 0$$

These equations are solved with *Global ODEs and DAEs (ge)* COMSOL Multiphysics interface under the initial conditions:

$$U_0|_{t=0} = V_0|_{t=0} = 0$$

The mass of the plunger is  $M_p = 5$  g, spring constant  $k = 3.6$  kN/m, damping coefficient  $D = 1$  N·s/m and initial spring compression force  $F_{init} = 3.6$  N.

The electromagnetic force on plunger is evaluated using interpolation function of data shown in Figure 6.

### 2.4 CFD Analysis

Fluid flow through the valve is modelled using the *Laminar Flow (spf)* COMSOL interface. The equations being solved are Navier-Stokes and continuity:

$$\rho \frac{\partial \mathbf{u}}{\partial t} + \rho(\mathbf{u} \cdot \nabla)\mathbf{u} - \nabla \cdot [-p\mathbf{I} + \mu(\nabla\mathbf{u} + (\nabla\mathbf{u})^T)] = 0$$

$$\rho \nabla \cdot \mathbf{u} = 0$$

where  $\mathbf{u}$  is fluid velocity,  $p$  is fluid pressure,  $\mu$  is dynamic viscosity, and  $\rho$  is density. Here the analysis was performed with the fluid being water.

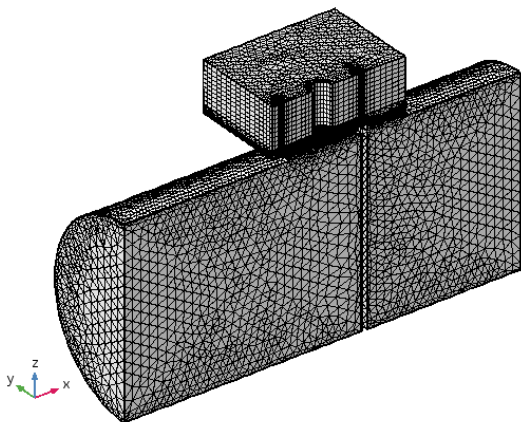
A fixed pressure  $P_{in}$  is specified at the channel inlet boundary. Assuming that the outlet is open to the atmosphere, a zero gauge pressure is imposed at the channel outlet boundary. A symmetry boundary condition is applied at the symmetry plane  $y = 0$ .

The hydrodynamic force on the plunger is calculated by integration of the fluid pressure over the plunger surface:

$$F_{CFD} = \int_{\partial\Omega} p dS$$

Fluid flow equations are solved in the fluid domain with moving boundaries. The *Moving Mesh (ale)* COMSOL interface is used to couple plunger dynamics with fluid flow. Coupling is achieved by imposing the *Prescribed Mesh Displacement* boundary condition at the plunger/fluid interface according to the plunger position dependent variable  $U_0$ .

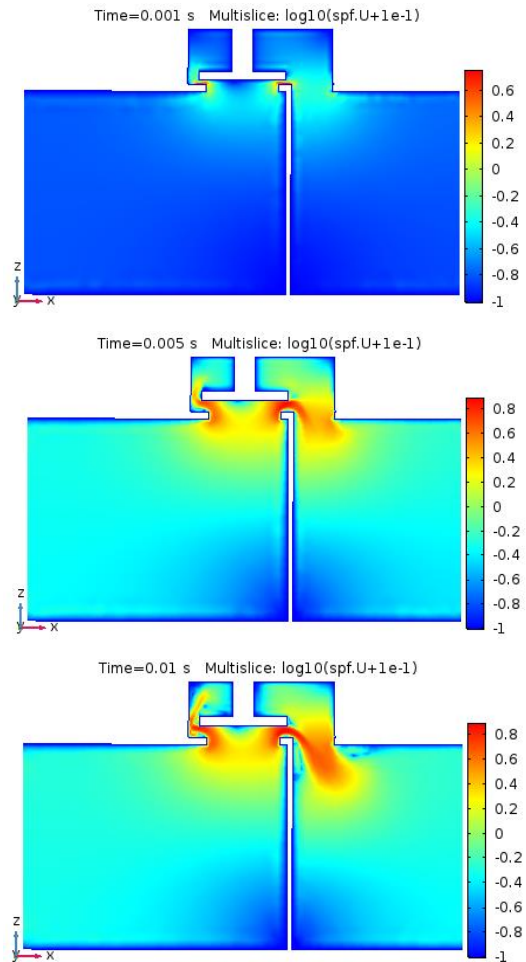
The mesh used for the CFD analysis is shown in Figure 8 which produces approximately 1.2M degrees of freedom.



**Figure 7.** Mesh used for the CFD analysis.

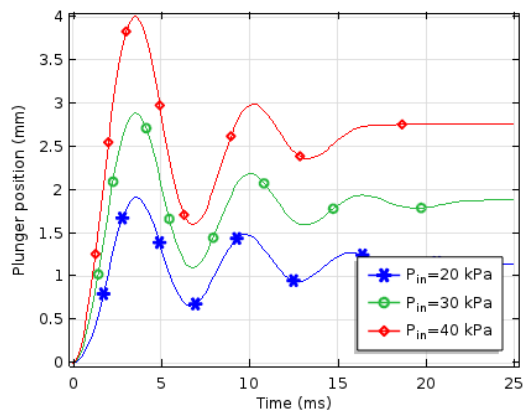
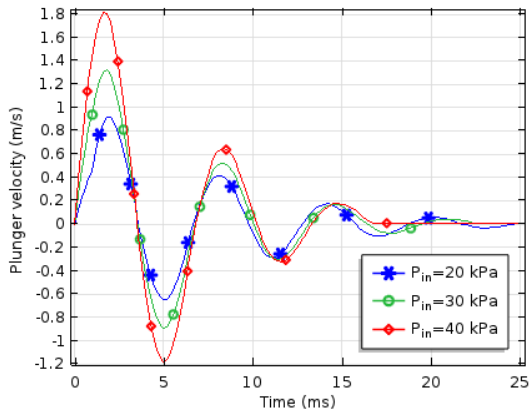
### 3. Results

Results for the velocity distribution of the fluid in the channel for several time instances are shown in Figure 8.



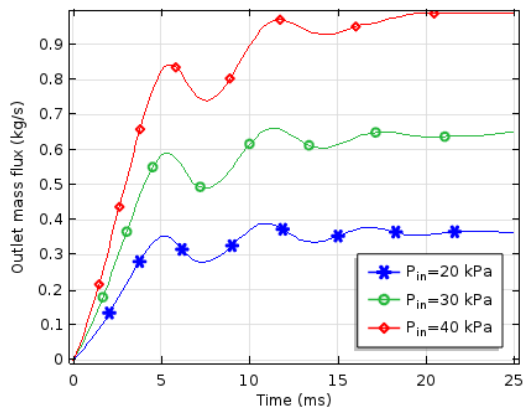
**Figure 8.** Fluid velocity distribution during valve opening at 1 ms, 5 ms, and 10 ms.

Figure 9 shows the predicted variation in the plunger velocity and displacement as a function of time. Valve movement starts from a nearly closed position (initial gap is 0.2 mm) then after series of oscillations reaches a steady-state position.



**Figure 9.** Plunger dynamics history plots for various inlet pressure.

The fluid outlet mass flux variation as a function of time is shown in Figure 10.



**Figure 10.** Fluid outlet mass flux.

## 6. Conclusions

This work analyzes the behavior of an electromagnetically controlled fluid flow valve. COMSOL Multiphysics has been applied to predict operational characteristics of an electromagnetic flow valve using a fully coupled electromagnetic-fluid-structure analysis.