



Understanding Transport Phenomena Concepts in Chemical Engineering with COMSOL Multiphysics®

Erick S. Vasquez, Ph.D.

Department of Chemical and Materials Engineering, University of Dayton,
Dayton, OH, USA

Session: Computational Fluid Dynamics 2

COMSOL
CONFERENCE
2017 BOSTON



Overview

- Introduction and objectives
- Governing Equations
- COMSOL Multiphysics® simulations
 - Flow in a pipe
 - Flow between parallel plates
 - Heat Conduction through a plane
 - Flow past a cylinder
 - Transient Diffusion
- Class project
- Survey results
- Conclusions

Introduction

- Transport Phenomena (at UD) at an undergraduate level
 - Transport Phenomena I
 - Transport Phenomena II

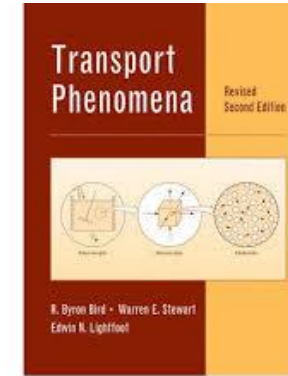

- Emerging Teaching Approaches:

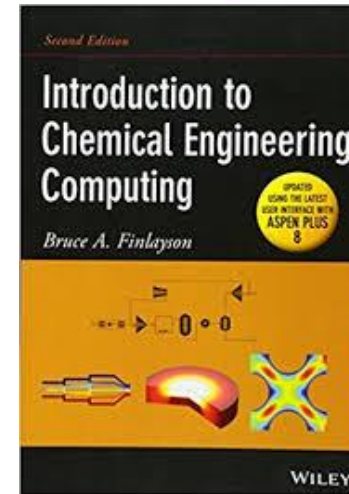
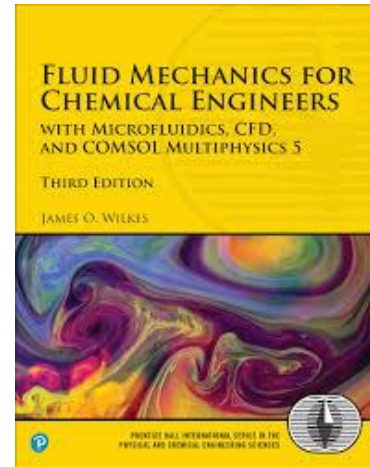
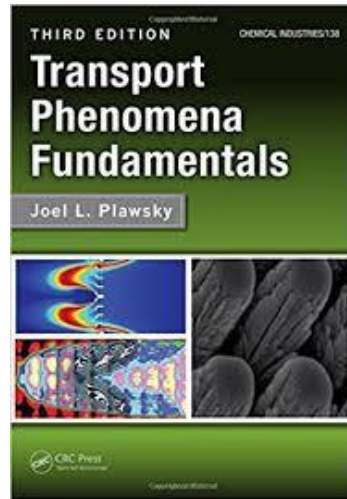

- Can the students learn better using simulations in the classroom?

*Note: This course is taught to students who have not taken any modeling class

Objectives

- Teach the students how to setup and run basic cases in COMSOL Multiphysics®
- Use a **Hands-on** approach teaching method: The students had complete access to the software and performed the simulations with guidance from the instructor simultaneously.
- **Visualize** results in unsteady state conditions for problems covered in class.
- **Assess** Simulations tool as an effective teaching tool

Governing Equations

Momentum
Transport



Continuity Equation

$$\rho \nabla \cdot (\mathbf{u}) = 0$$

Navier-Stokes Equation

$$\rho(\mathbf{u} \cdot \nabla)\mathbf{u} = \nabla \cdot [\rho \mathbf{I} + \mu(\nabla \mathbf{u} + (\nabla \mathbf{u})^T)] + \mathbf{F}$$

Heat
Transport



Fourier's law of Heat Conduction

$$\mathbf{q} = -k \nabla T$$

Energy Equation

$$\rho C_p \frac{\partial T}{\partial t} + \rho C_p \mathbf{u} \cdot \nabla T + \nabla \cdot \mathbf{q} = Q + Q_{\text{ted}}$$

Mass
Transport



Fick's Laws

$$\mathbf{N}_i = -D_i \nabla c_i$$

$$\frac{\partial c_i}{\partial t} + \nabla \cdot (-D_i \nabla c_i) = R_i$$

- Easy implementation of equations in COMSOL Multiphysics®
- Interactive selection of “physics” models
- Students do not need to discretize equations
- Students can focus on data analysis and discussion of the results

Flow in a pipe

Derivation of a velocity profile (1-D) for laminar flow using a shell balance

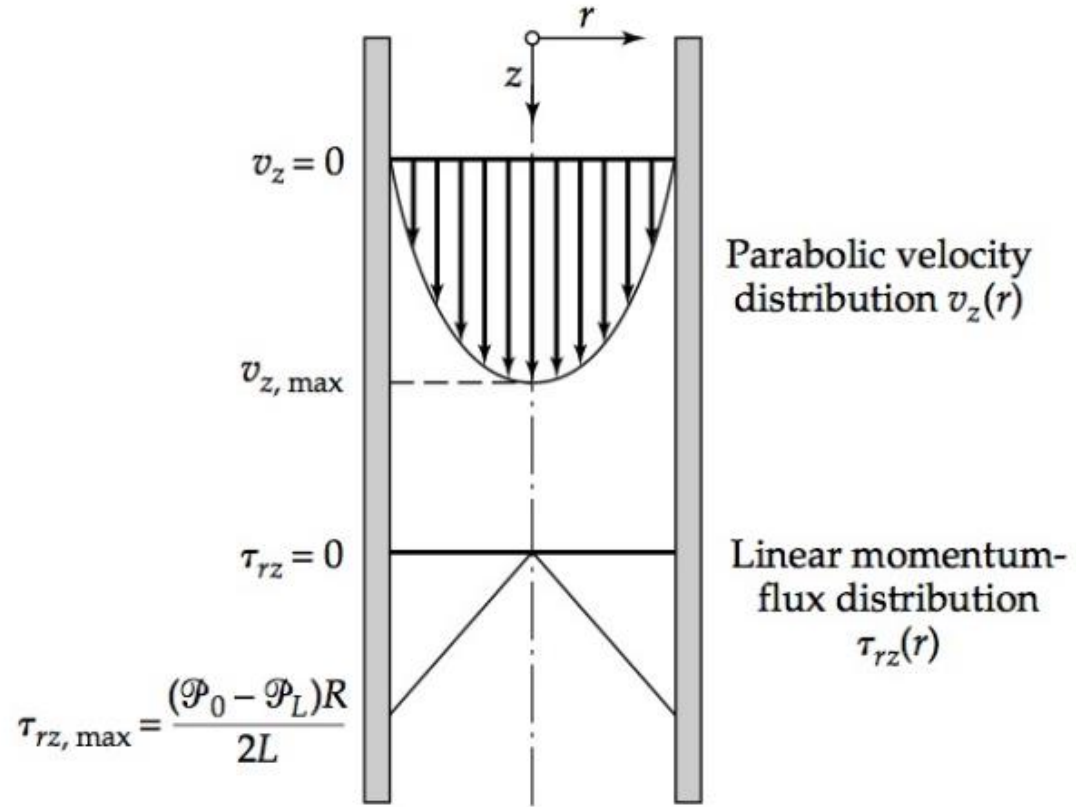
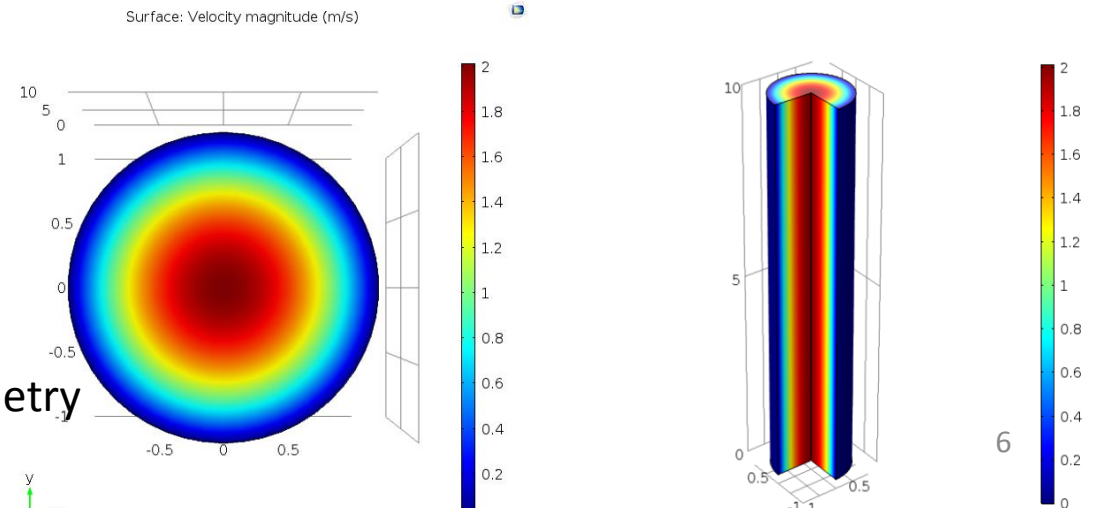
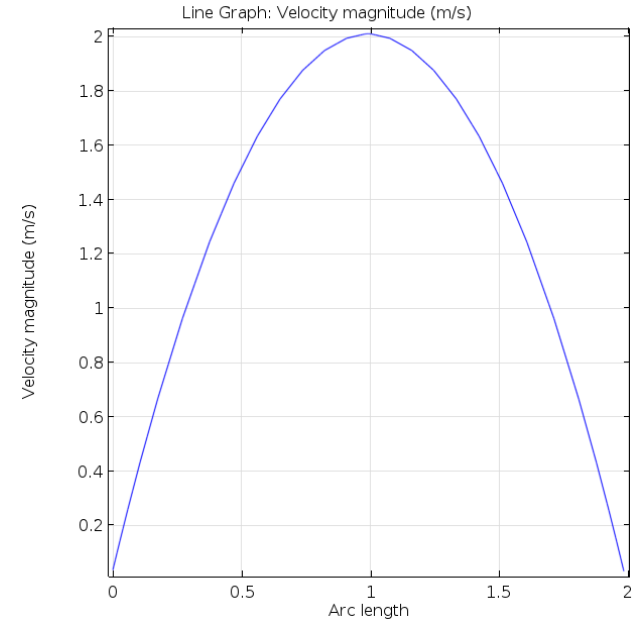

Image source: BSL, 2nd revised edition

COMSOL Multiphysics® visualization



- With COMSOL, Students obtain a better understanding of symmetry Boundary conditions.

Flow between parallel plates

A) Velocity magnitude for flow between parallel plates and B) Turbulent velocity profile (inset) and pressure drop illustration.

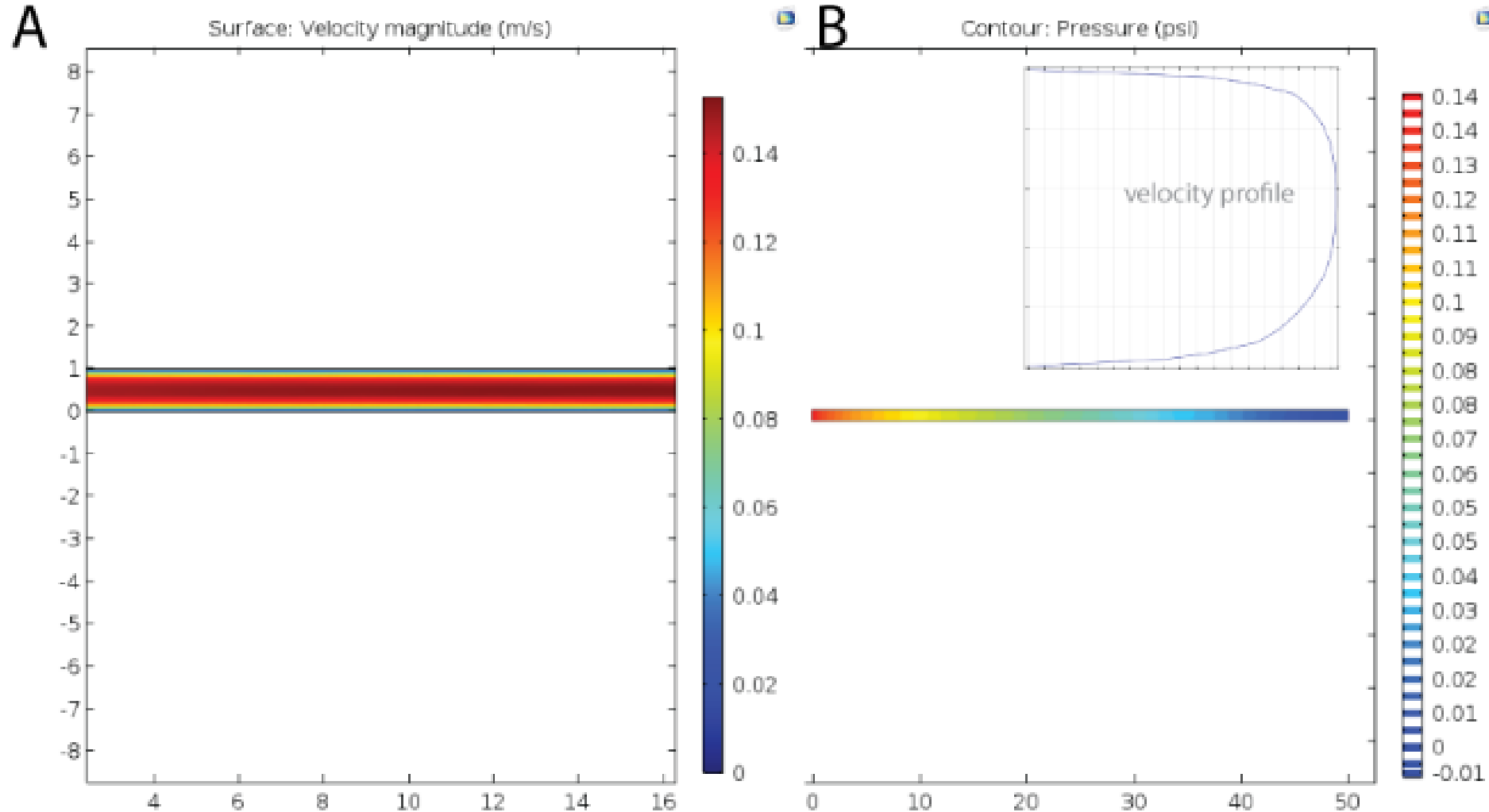

Path forward

- Model a manifold apparatus and validate the results with experimental values

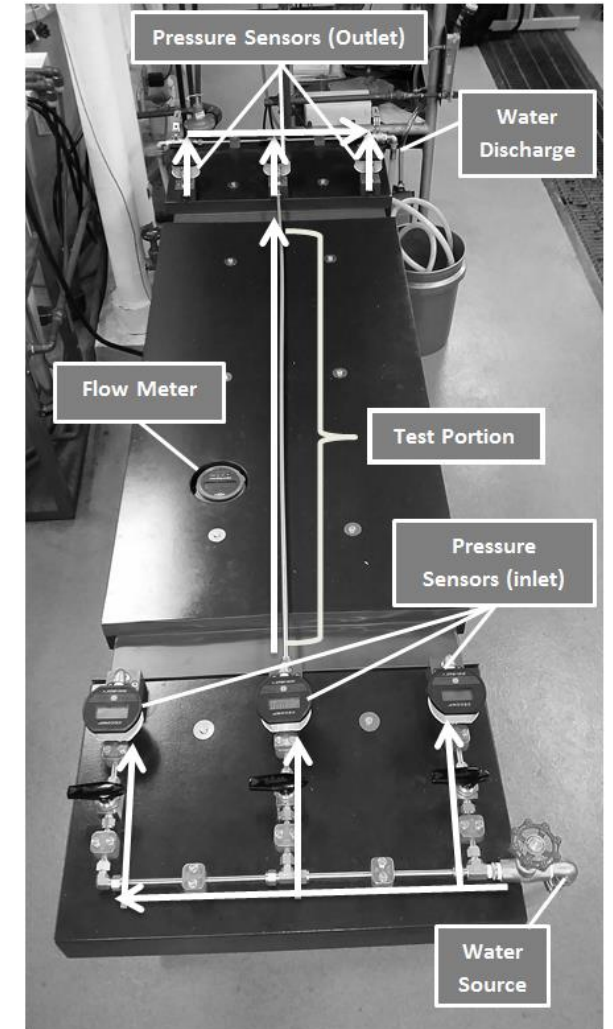

Unsteady state conditions: Flow past a solid

Traditional example given in class

$$v_x \frac{\partial v_x}{\partial x} = O\left(\frac{v_\infty^2}{l_0}\right); v_y \frac{\partial v_x}{\partial y} = O\left(\frac{v_\infty^2}{l_0}\right) \quad \frac{\partial^2 v_x}{\partial x^2} = O\left(\frac{v_\infty}{l_0^2}\right) \quad \frac{\partial^2 v_x}{\partial y^2} = O\left(\frac{v_\infty}{\delta_0^2}\right) \quad (4.4-6)$$

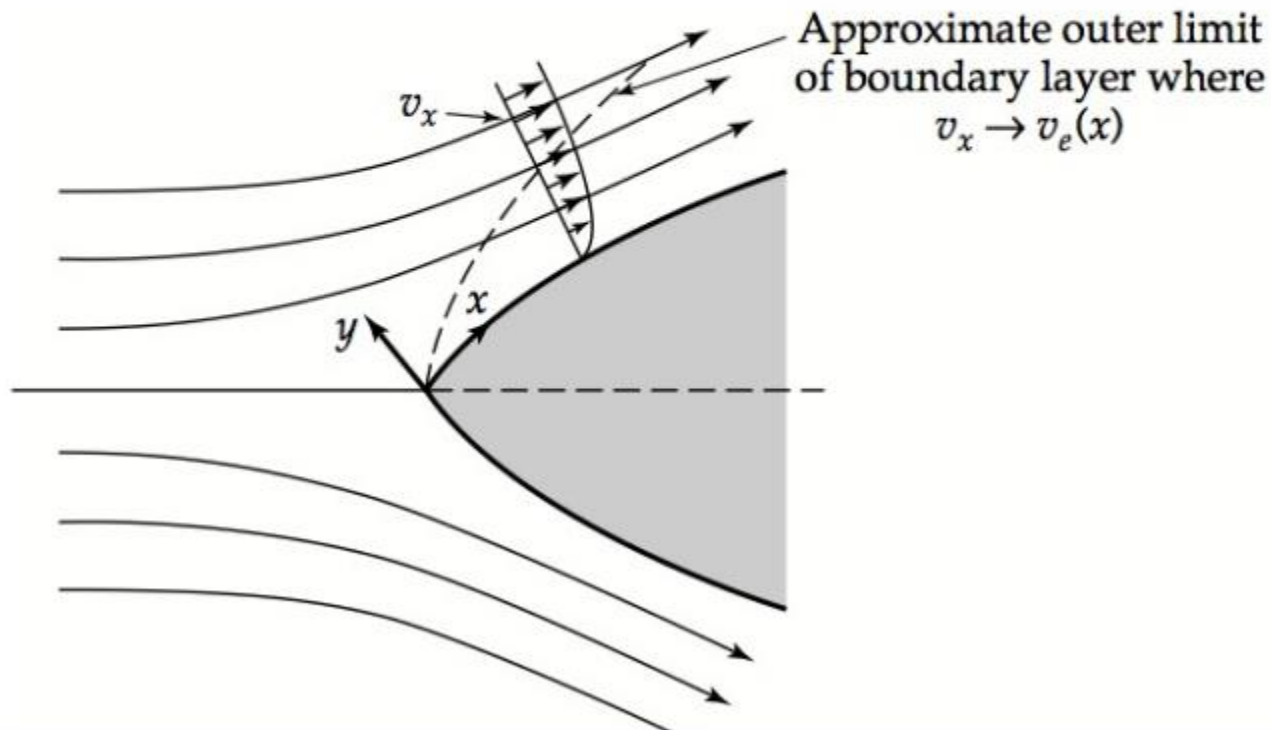
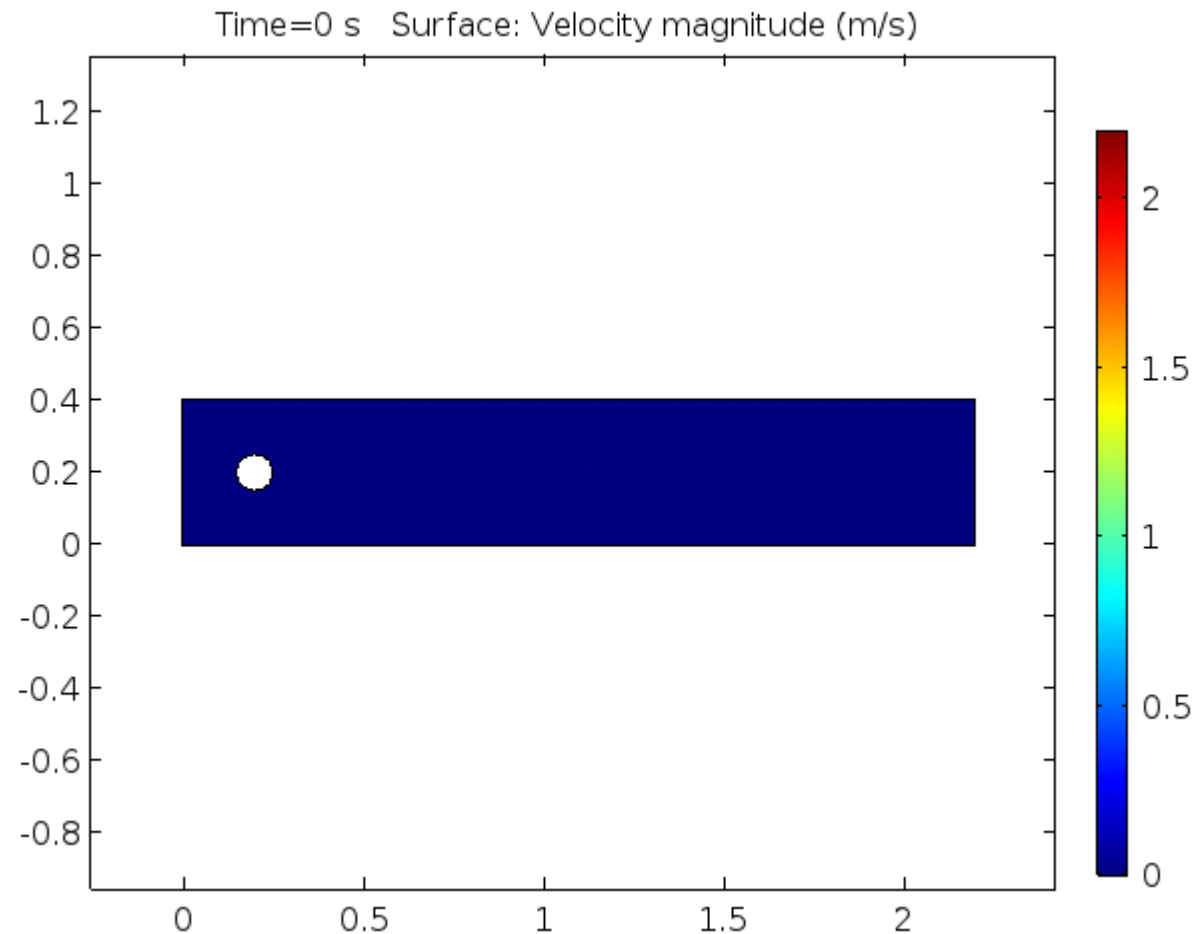

Fig. 4.4-1. Coordinate system for the two-dimensional flow around a submerged object. The boundary-layer thickness is greatly exaggerated for purposes of illustration. Because the boundary layer is in fact quite thin, it is permissible to use rectangular coordinates lo-

Flow between parallel plates

Without experiments to confirm transitional regime or boundary layer theory, simulations are an excellent alternative for understanding transient experiments.



Heat Transport Example

- Heat Conduction through composite walls

Temperature distribution across a concrete plane from 160° to 20 °C.

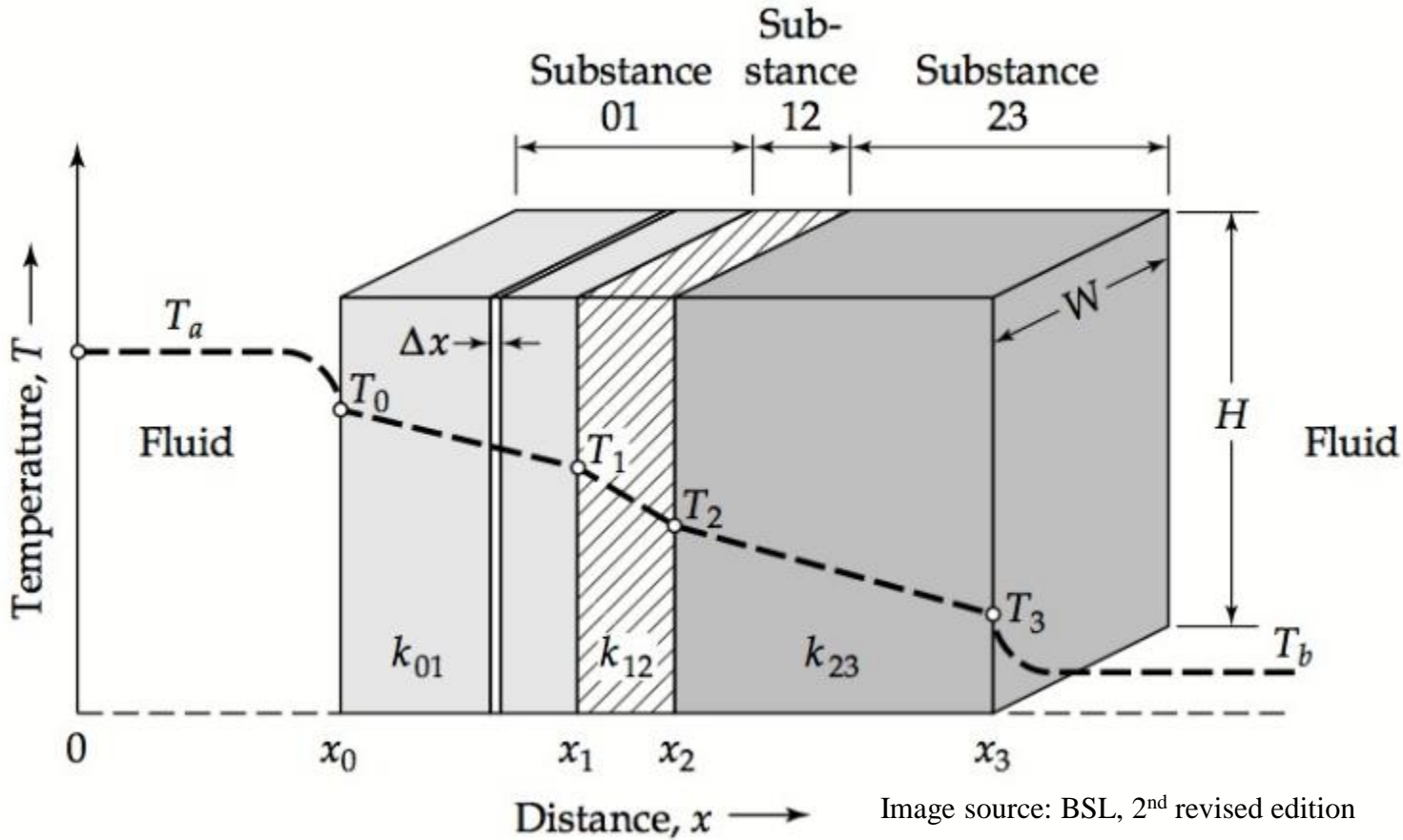
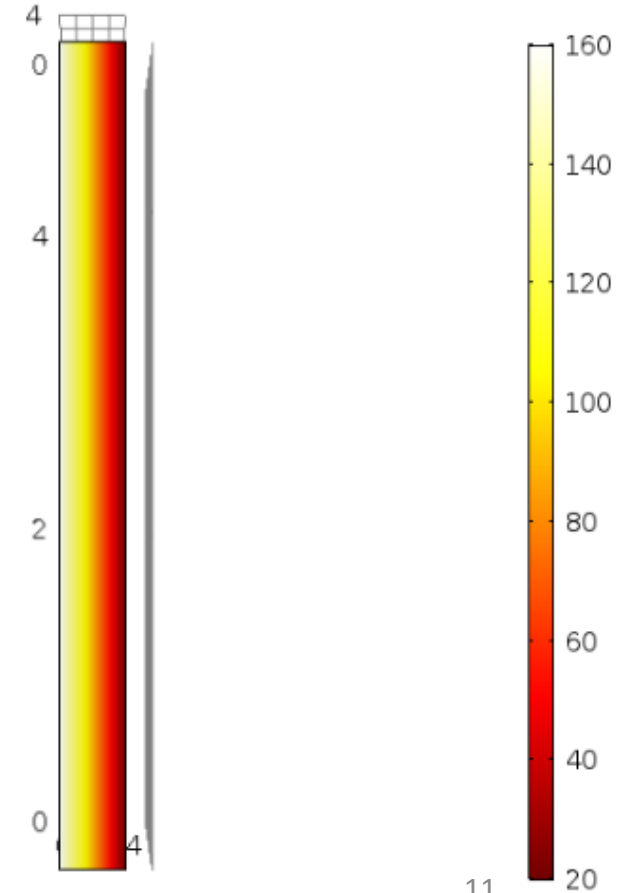

Image source: BSL, 2nd revised edition

Surface: Temperature (degC)



Diffusion example

- In-class: 1-D and unsteady state mathematical solution (Dimensionless variables – PDE)

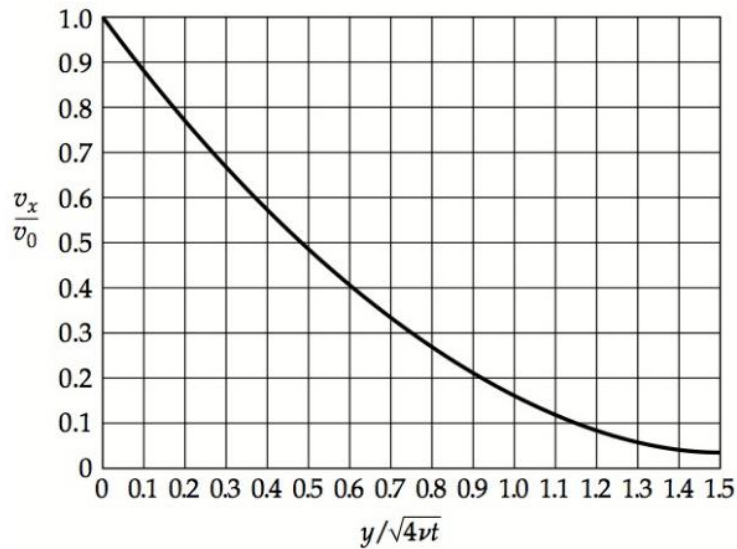
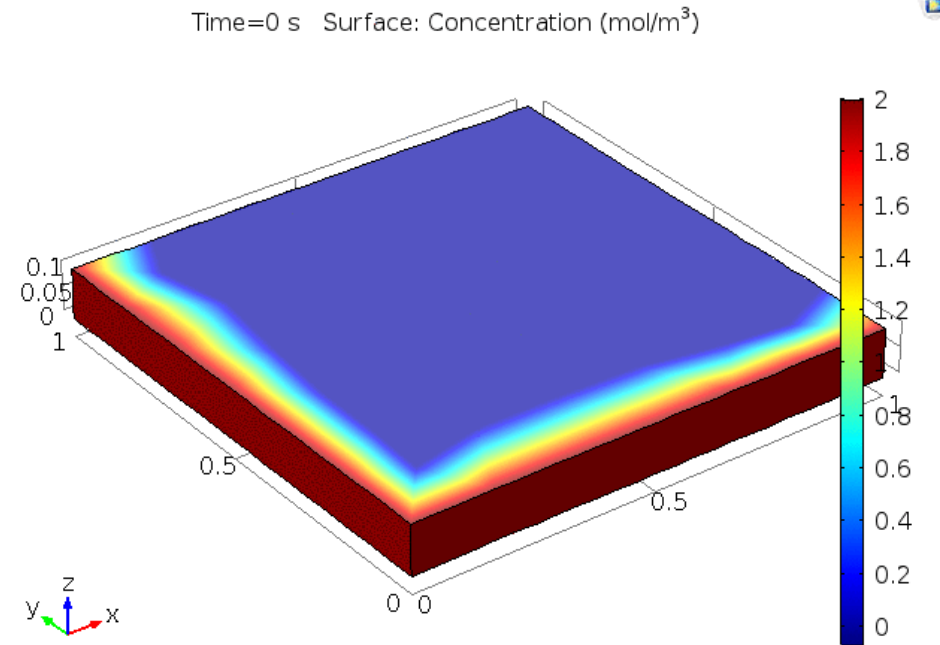

Fig. 4.1-2. Velocity distribution, in dimensionless form, for flow in the neighborhood of a wall suddenly set in motion.

Application of the two boundary conditions makes it possible to evaluate the two integration constants, and we get finally

$$\phi(\eta) = 1 - \frac{\int_0^\eta \exp(-\bar{\eta}^2) d\bar{\eta}}{\int_0^\infty \exp(-\bar{\eta}^2) d\bar{\eta}} = 1 - \frac{2}{\sqrt{\pi}} \int_0^\eta \exp(-\bar{\eta}^2) d\bar{\eta} = 1 - \text{erf } \eta \quad (4.1-14)$$

Image source: BSL, 2nd revised edition



Project: Shell and tube HX

Experimental and Theoretical overall heat transfer coefficient

$$\dot{m}_c * C_{pc} * (T_{cb} - T_{ca}) = U_{exp} * A * \Delta T_L$$

$$\Delta T_L = \frac{\Delta T_1 - \Delta T_2}{\ln \frac{\Delta T_1}{\Delta T_2}}$$

$$U_{theo} = \left(\frac{1}{h_i} + \frac{r_o - r_i}{k_{copper}} + \frac{1}{h_o} \right)^{-1}$$

$$h_i = \frac{0.023 * k}{D_i} * Re^{0.8} * Pr^{0.33} \quad h_o = \frac{0.2 * k}{D_o} * \left(\frac{D_o * G_e}{\mu} \right)^{0.6} * \left(\frac{C_p * \mu}{k} \right)^{0.33}$$

Project: Shell and tube HX

Shell and tube heat exchanger simulations showing temperature streamline with air(top) and Freon(bottom) as the materials under the same conditions.

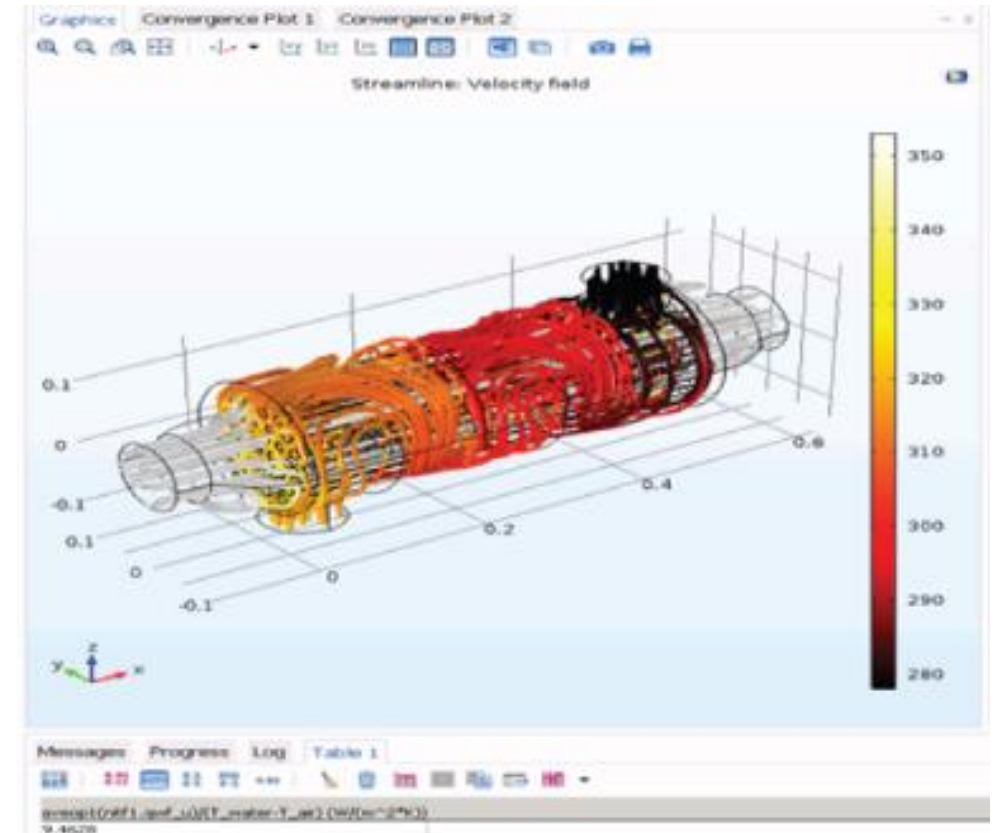

Student Assessment: Survey

	Strongly Disagree	Disagree	Neutral	Agree	Strongly Agree
1. Transport Phenomena helped me to connect various topics learned in my previous Eng. Classes					
2. Simulations helped me to obtain a better understanding of Transport Phenomena					
3. The in-class examples helped me to visualize results in 3-D					
4. COMSOL® modeling helped me to understand the relationship between actual experiments and equipment design/ mathematical predictions					
5. COMSOL® results are easy to understand and manipulate					
6. COMSOL® is a software with a user friendly interface					
7. By using COMSOL®, I am more interested in Transport phenomena					
8. Simulations/videos were useful to connect with the theory and understand multidimensional flow					
9 <i>The following modules were useful for my learning:</i>					
a. flow in a pipe/ flow between two plates/ Heat conduction through a plane					
b. Flow past a cylinder					
c. Diffusion/Tubular reactor					
10. The project (Shell and tube HX) was effective in connecting new concepts in Chemical Engineering					
11. The instructor should spend more class time with computer simulations to enhance my learning					

Using “Simulations” in the classroom

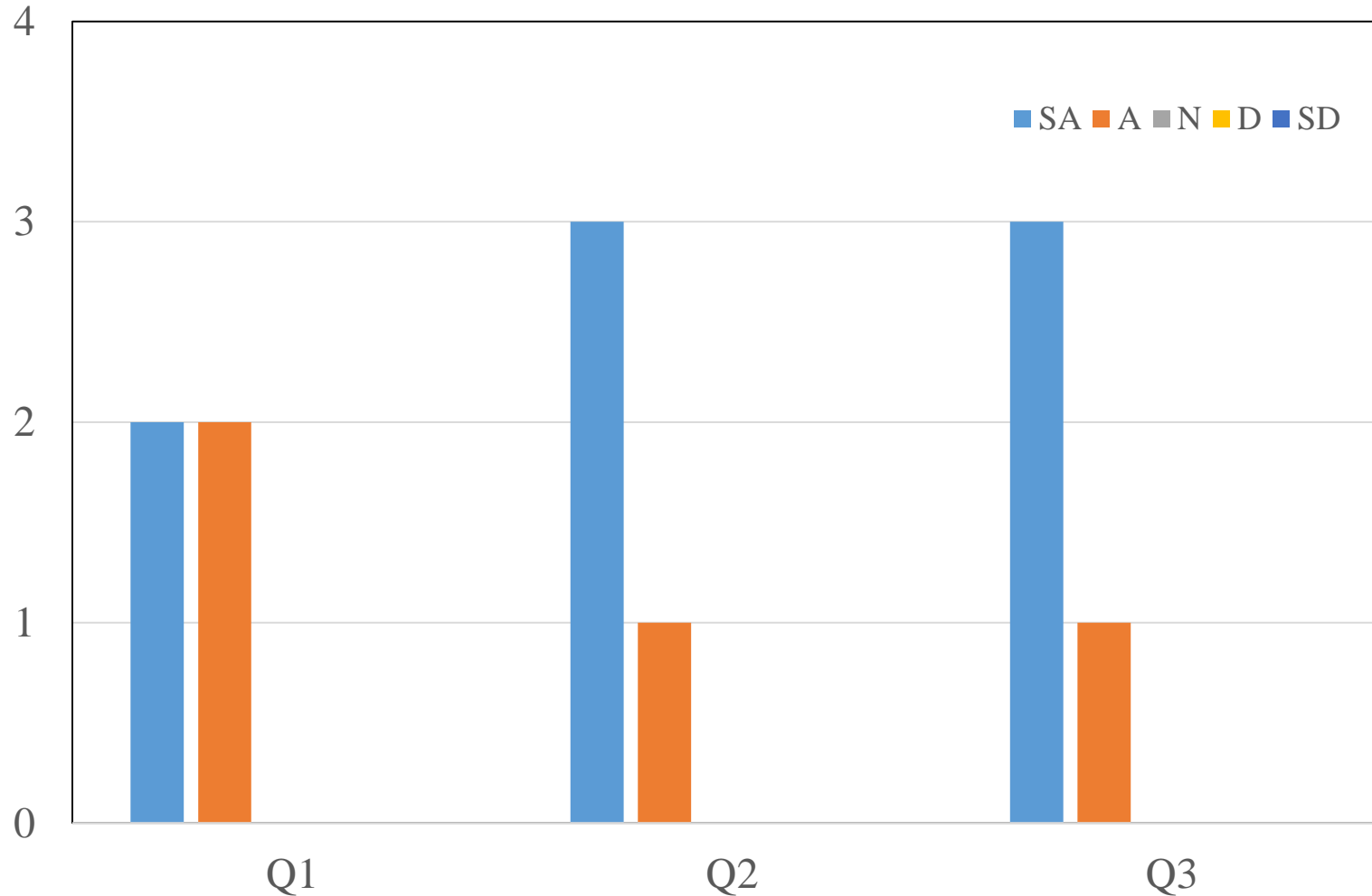

Q1. Transport Phenomena helped me to connect various topics learned in my previous Eng. Classes

Q2. Simulations helped me to obtain a better understanding of Transport Phenomena

Q3. The in-class examples helped me to visualize results in 3-D

Using COMSOL Multiphysics® in the classroom

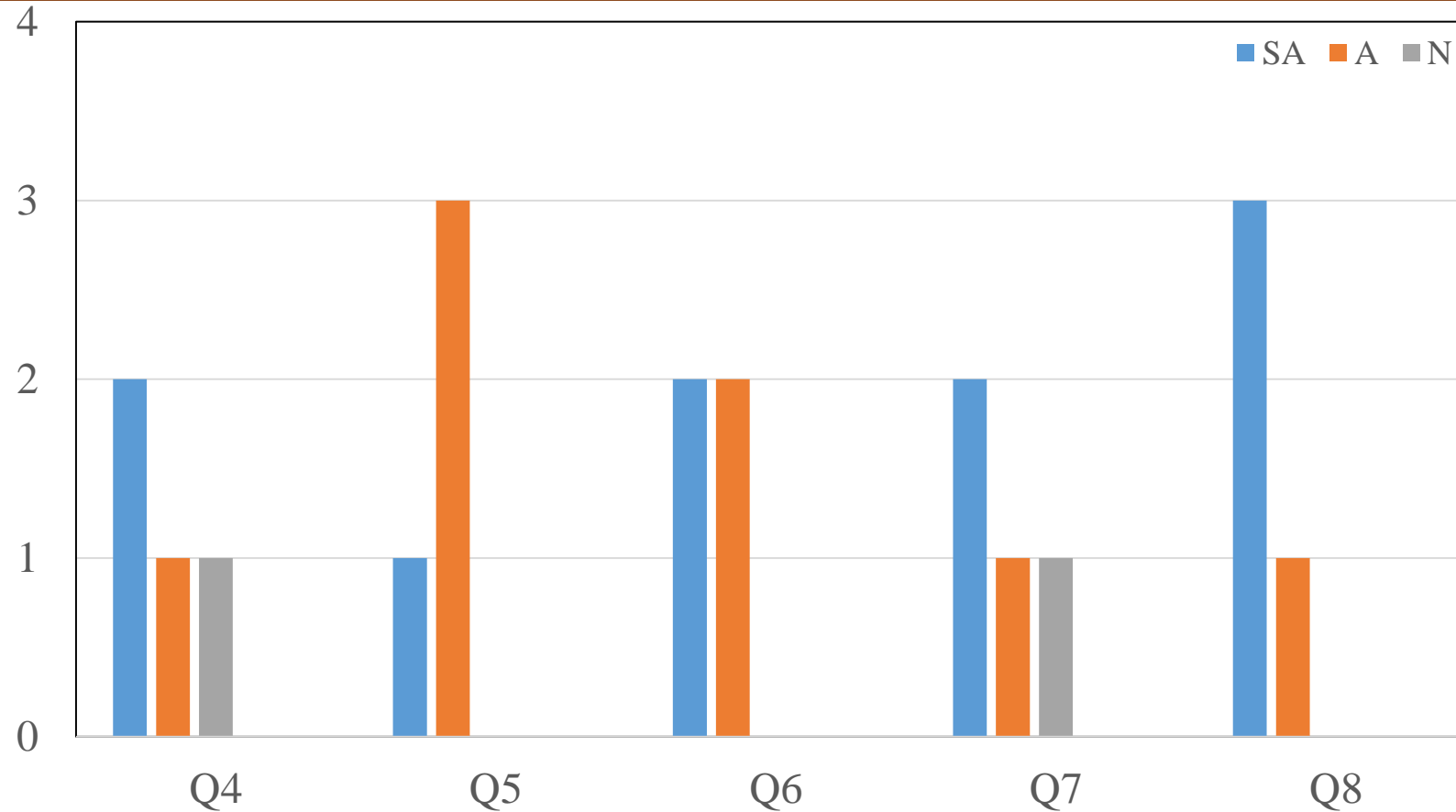

Q4. COMSOL Multiphysics® modeling helped me to understand the relationship between actual experiments and equipment design/ mathematical predictions

Q5. COMSOL Multiphysics® results are easy to understand and manipulate

Q6. COMSOL Multiphysics® is a software with a user friendly interface

Q7. By using COMSOL Multiphysics®, I am more interested in Transport phenomena

Q8. Simulations/videos were useful to connect with the theory and understand multidimensional flow

COMSOL Multiphysics® Modules and class time

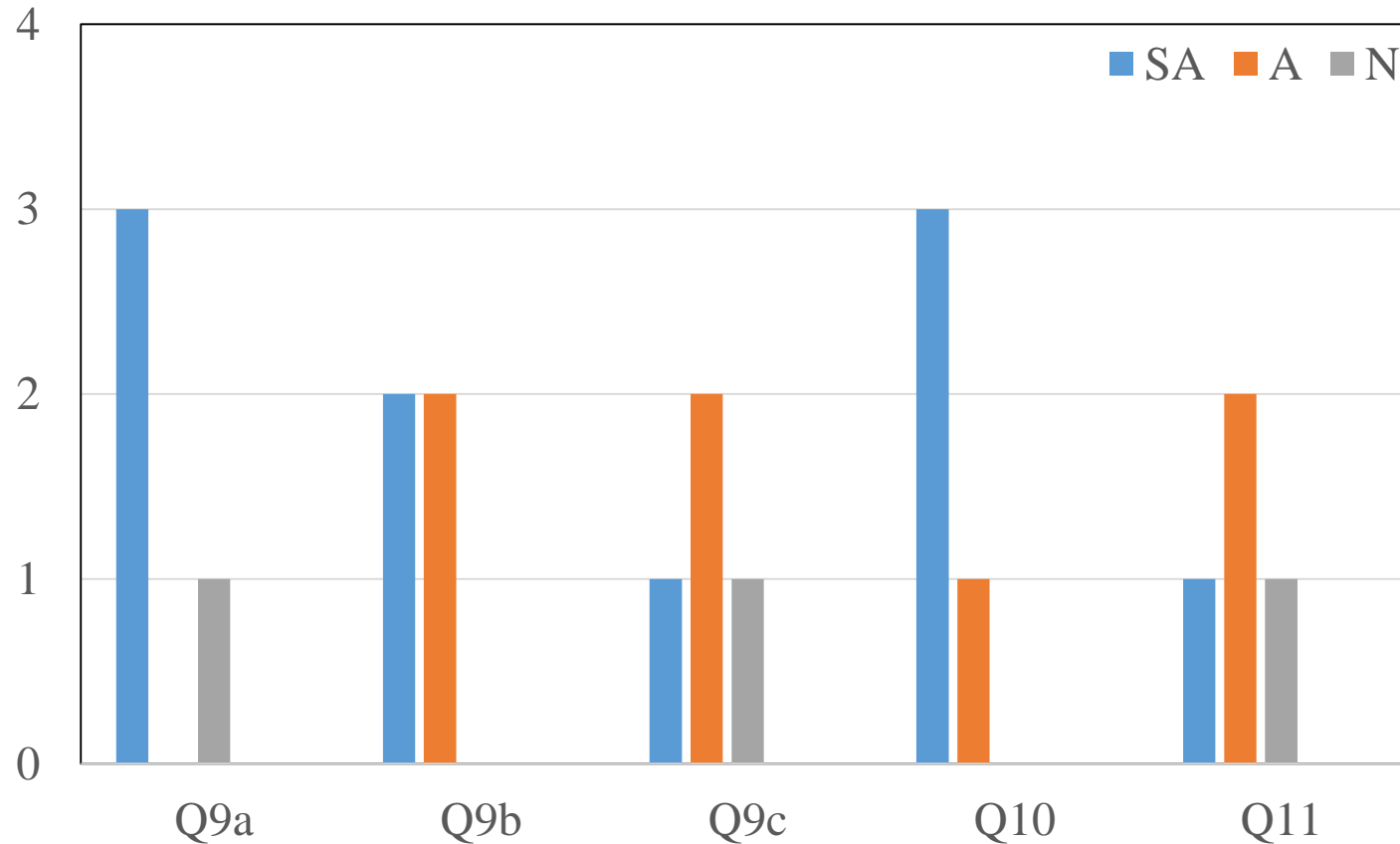

Q9. *The following modules were useful for my learning:*

- flow in a pipe/ flow between two plates/ Heat conduction through a plane
- Flow past a cylinder
- Diffusion/Tubular reactor

Q10. The project (Shell and tube HX) was effective in connecting new concepts in Chemical Engineering

Q11. The instructor should spend more class time with computer simulations to enhance my learning

Conclusions

- The students surveyed in this course were satisfied by the implementation of a modeling software in the Transport Phenomena class.
- The students were completely satisfied on using COMSOL Multiphysics® for this class since it is very user-friendly.
- In future courses, both simulations and mathematical results will be covered at the same time to compare mathematical or experimental results with simulation values. The **Application builder** will be used as a learning tool.
- COMSOL Multiphysics® will be used for modeling the equipment in the Transport Phenomena laboratory and in the Unit Operations laboratory in order to validate simulations results.

Acknowledgments & References

- The Mechanical and Electrical Engineering Department at the University of Dayton
- Bird, B., Steward, W. & Lightfoot, E. *Transport Phenomena* (revised 2nd edition) John Wiley & Sons. New York (2007).
- Bird, R. B. Transport phenomena. *Appl. Mech. Rev.* **55**, R1–R4 (2002).
- Geike, R. & Berlin, T. F. H. COMSOL multiphysics in education—chemical reactions, heat and mass transfer. *Proceedings of the COMSOL Conference* **1**, (2008).
- Mills, P. L., Vasilev, M. & Sharma, P. Application of COMSOL Multiphysics® Software® in Transport Phenomena Educational Processes. *Proceedings of the COMSOL Conference in Boston*, (2015)
- Pieper, M. & Schulz, S. Teaching Simulation Methods with COMSOL Multiphysics®. *Proceedings of the COMSOL Conference in Cambridge*, (2014)
- Plawsky, J. L. *Transport phenomena fundamentals*. CRC Press, (2014).